

M570CarryTEC by **OMTEC**

ELEGANCE LOW V1 CROSS BAR

MONTAJ TALİMATI**FITTING INSTRUCTIONS****MONTAGEANLEITUNG****RIDELLES DE TOIT**

(TR) Açıkça belirtmek isteriz ki yetkili montajcının talimatına uymadığından ötürü gerçekleşen hasar ürünün tazmin hakkını düşürür, özellikle de ürün sorumluluğu yasasından kaynaklanan durumlar için geçerlidir.

Parçalar ve montaj talimatları duyurusu yapılmadan değişime tabi olabilir, lütfen talimatın tamamını okuyup anladığınızdan emin olduktan sonra montaja başlayınız.

(GB) We expressly point out that assembly not carried out properly by a competent installer will result in cancellation of any right to damage compensation, in particular those arising by virtue of the product liability act.

Contents of these kits and their fitting manuals are subject to alteration without notice, please ensure that these instructions are read and fully understood before commencing installation.

(D) Beachten Sie bitte, dass bei Schäden in Folge unsachgemäßen Einbaus sämtliche Garantieansprüche erlöschen.

Das Recht zu Änderungen an Inhalt von Montagesatz und Einbauanleitung ohne Vorankündigung bleibt vorbehalten. Lesen Sie vor dem Einbau diese Anleitung sorgfältig durch.

(FR) Nous tenons à insister tout particulièrement sur le fait que si ce produit n'est pas correctement assemblé par un technicien compétent, aucun droit de compensation ne sera recevable en cas de dommages, notamment les droits en vertu de la loi concernant la responsabilité à l'égard des produits.

Le contenu de ce produit, ainsi que des guides de montage qui les accompagnent est sujet à modifications sans préavis; lisez attentivement ces instructions avant de procéder à l'installation.

(NL) De installatie moet worden uitgevoerd door een erkende, competente installateur. Incorrecte montage kan leiden tot het vervallen van elk recht op schadecompensatie, met name die met betrekking tot product aansprakelijkheid.

De inhoud van deze kits en de installatiehandleidingen kunnen worden gewijzigd zonder kennisgeving. Zorg er voor, dat u deze instructies hebt gelezen en volledig begriipt voordat u met de installatie begint.



Uzun olan ara atkıyı önce ön tarafa deneyiniz.
Uygun değilse kısa ara atkıyı öne uzun olanı arkaya takınız.

Firstly, try the long crossbar to mount on the front,
If it is not suitable, mount the short crossbar
on the front and the long one to the rear.

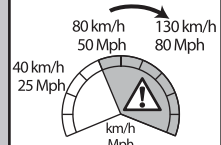
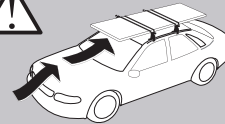

=

**Max.
75 kg****Max.
165 lbs**www.omtec.com.tr









M9696928_3 / Rev00 / 13.09.2024



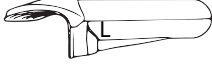

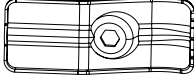
PARÇA LİSTESİ

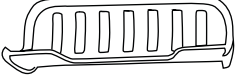
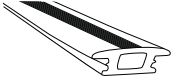
PART LIST / TEILELISTE / LISTA DE ACCESSORIOS

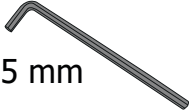
 A x 6	 B x 3	 C x 3	 D x 6 (M6 x 25)
 E x 6 (M6)	 F x 6	 G x 6	 H x 6
 I x 3	 J x 3	 5 mm K x 1	

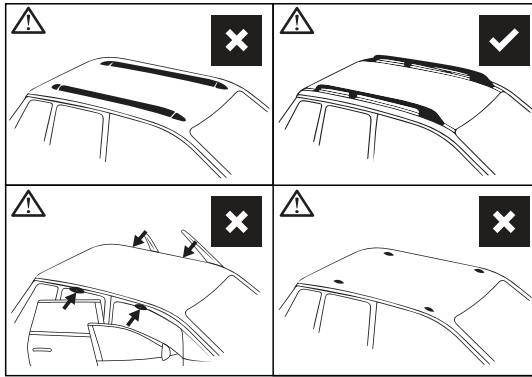

***Ürünün zarar görmemesi için yıkama sırasında NaOH (kostik) içerikli kimyasal kullanılmamalıdır.**

Protect the product from the chemicals which contain NaOH (sodiumhydroxide) in washing.

Damit die Ware nicht beschädigt wird, bitte keine chemischen Mittel wie NaOH (ätzende Mittel) verwen

N'utilisez pas de produits chimiques caustiques pendant le lavage pour éviter d'endommager le produit.

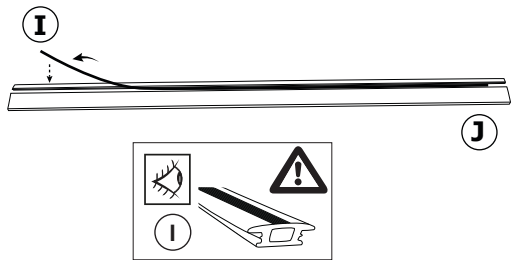
1

$$L = I + J$$

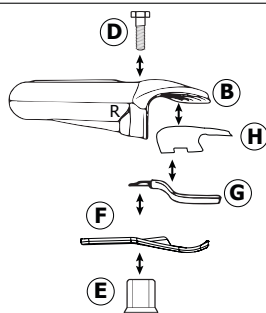
2

$$M = D + B + H + G + F + E$$

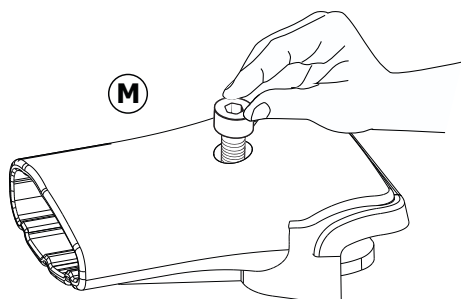
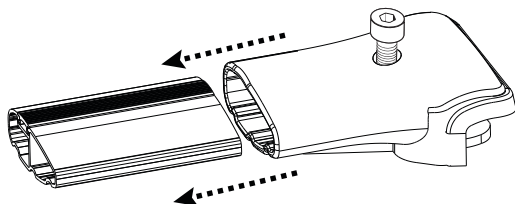
3**4****5**

AYARLANABİLİR / ADJUSTABLE / EINSTELLBAR

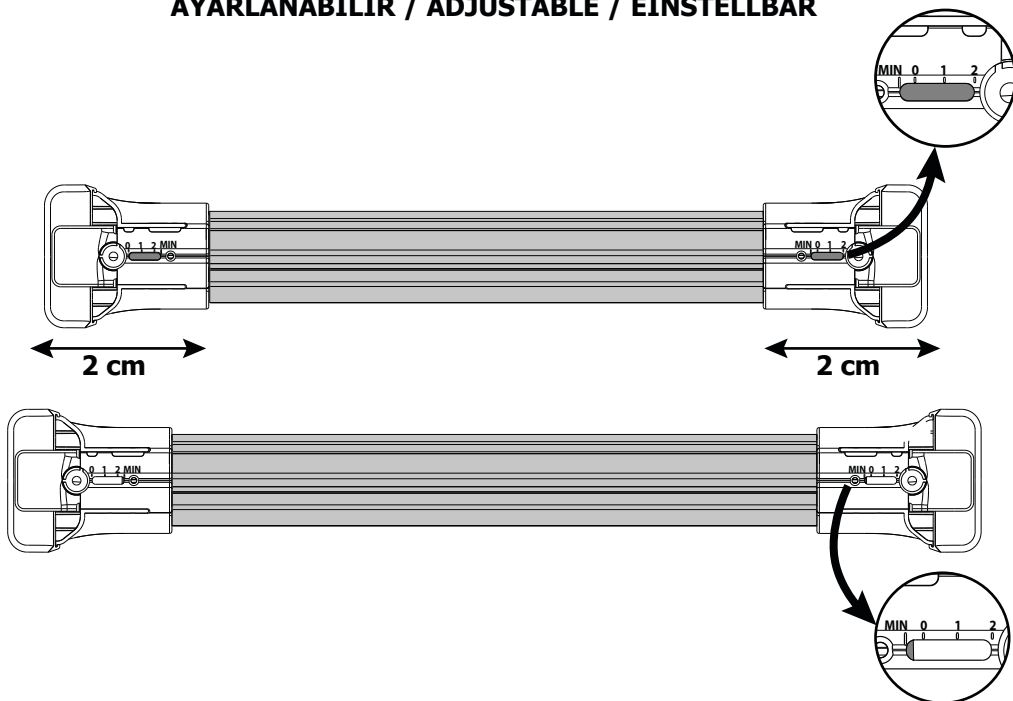

6

*Uzun olan ara atkırı önce ön tarafa deneyiniz. Uygun değilse kısa ara atkırı öne uzun olanı arkaya takınız.

*Firstly, try the long crossbar to mount on the front, If it is not suitable, mount the short crossbar on the front and the long one to the rear.

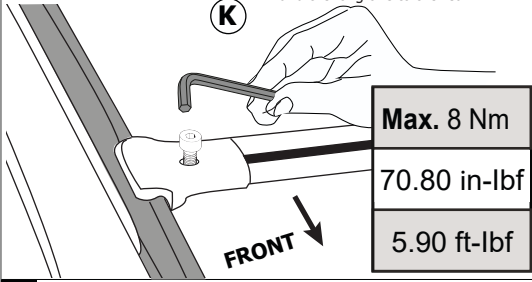
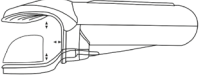
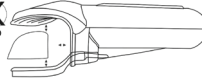
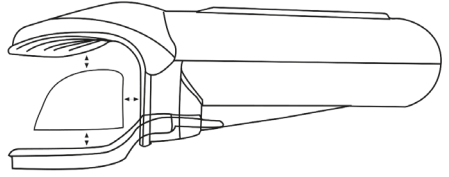
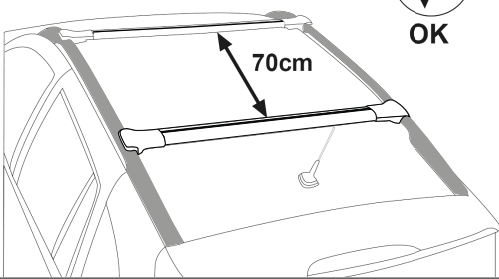
**7****8****9**

Max. 8 Nm
70.80 in-lbf
5.90 ft-lbf

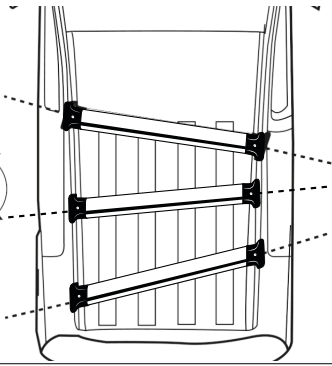
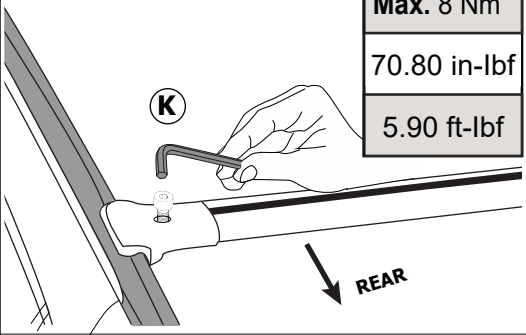
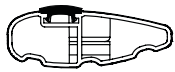
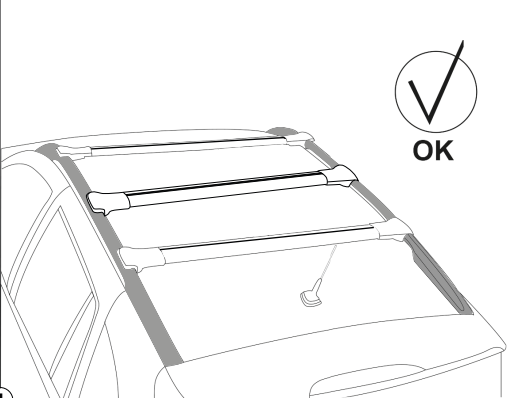
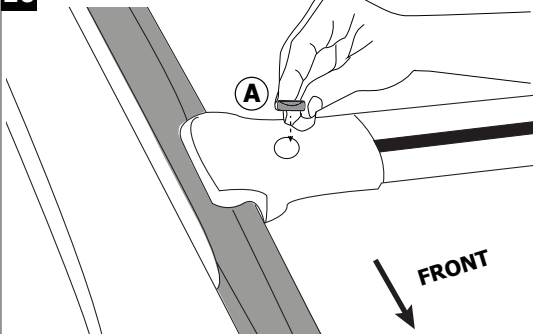
K**FRONT****10****A****4**