

A

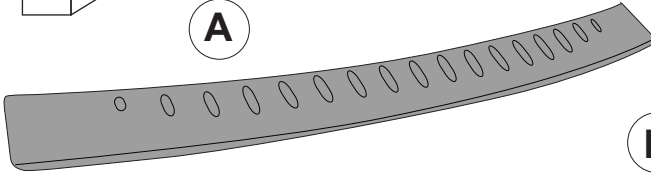

B



C

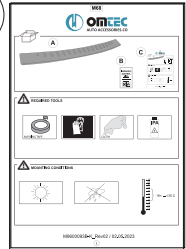

REQUIRED TOOLS

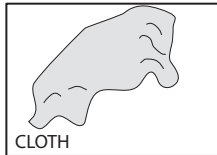

MOUNTING CONDITIONS

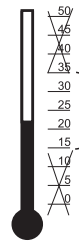
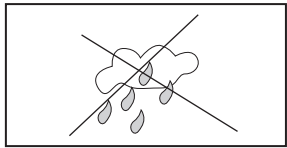
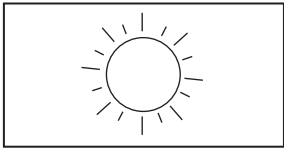

18 < < 35 C



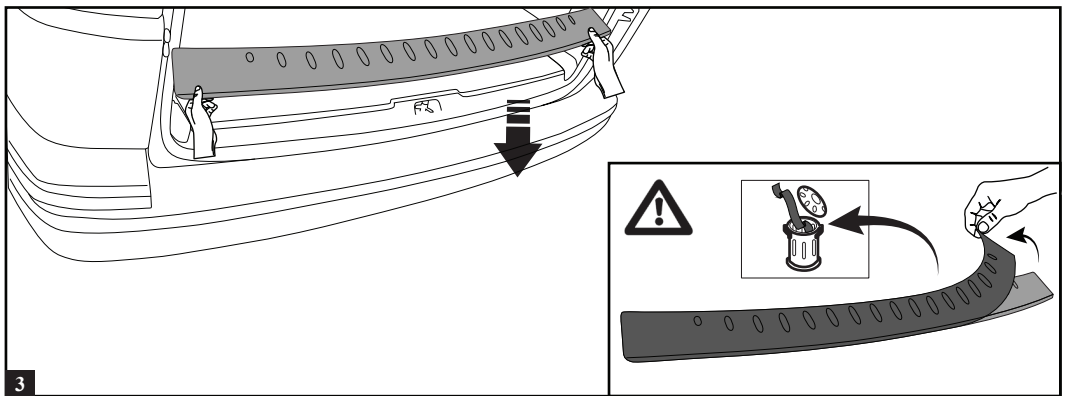
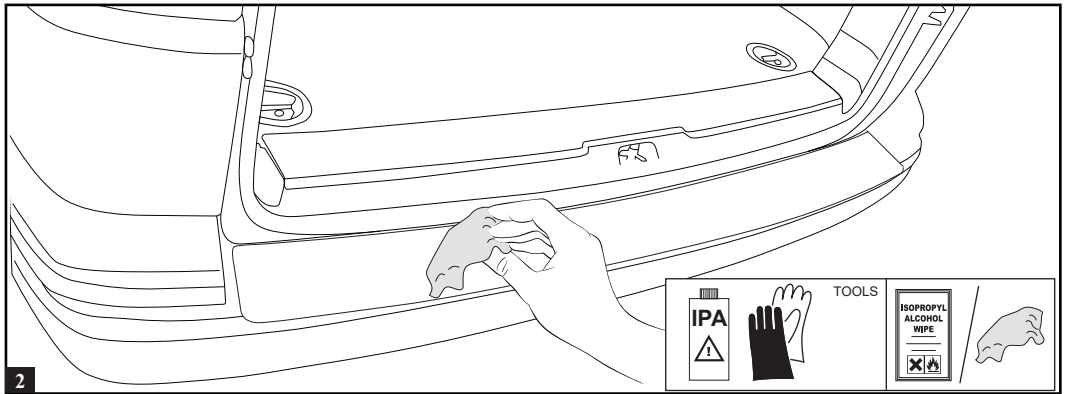
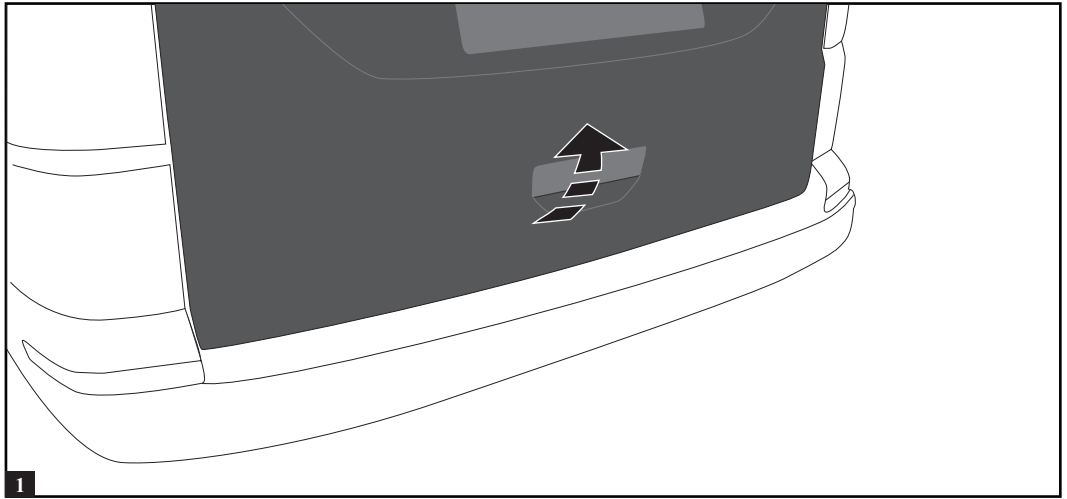

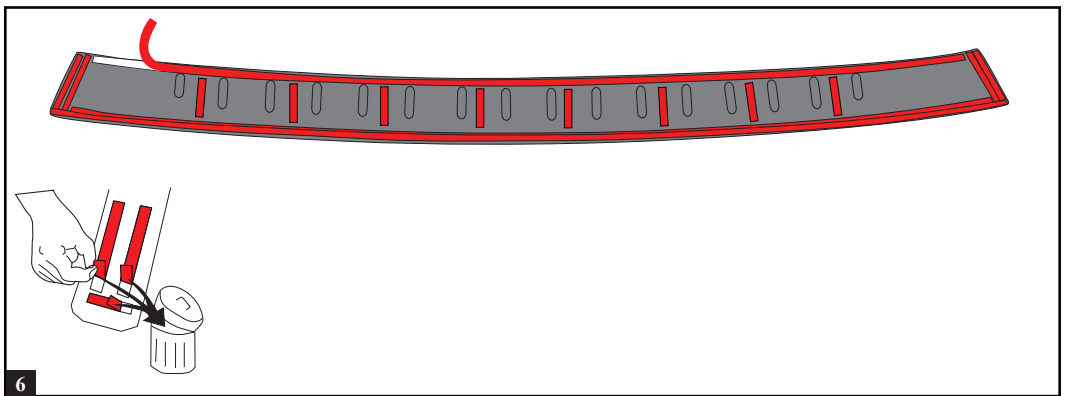
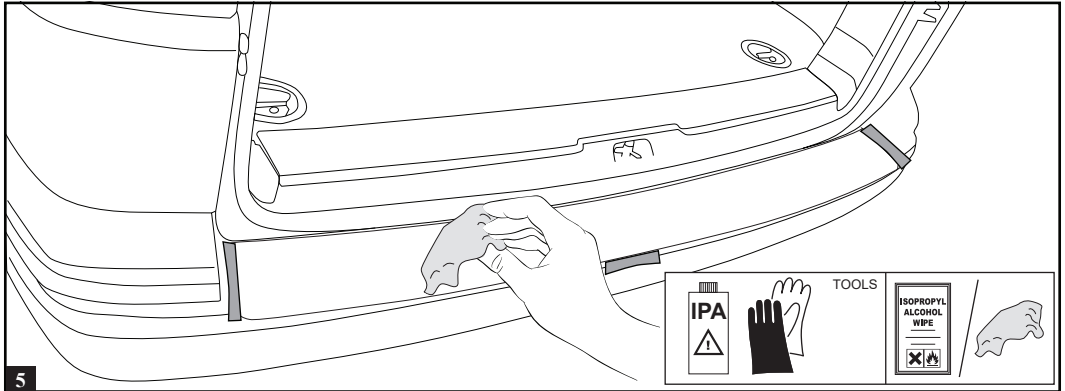
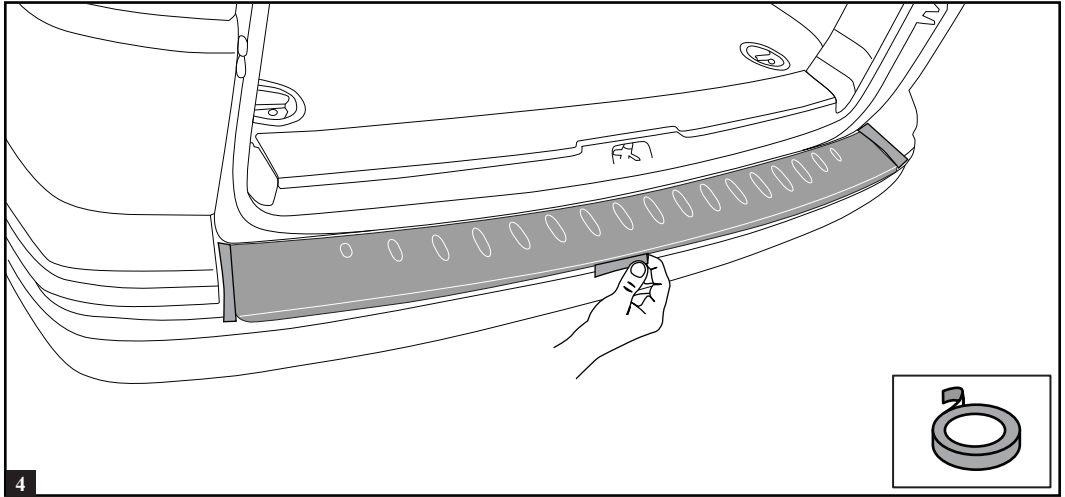

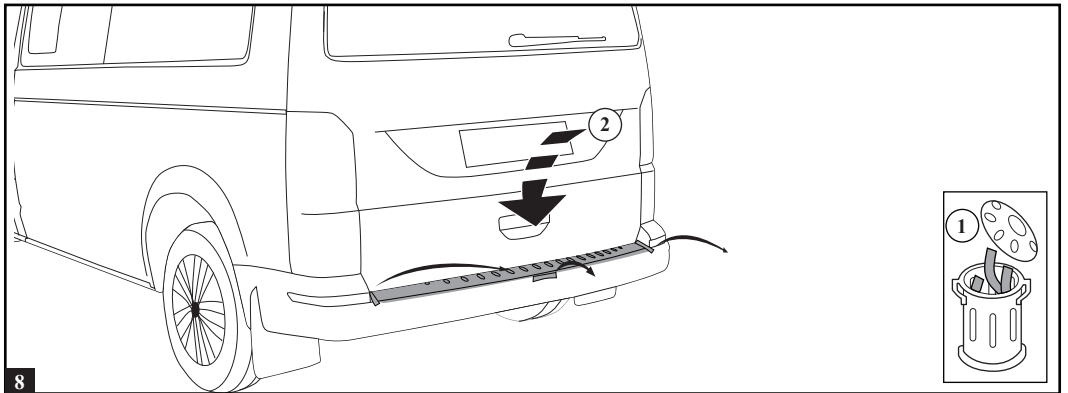
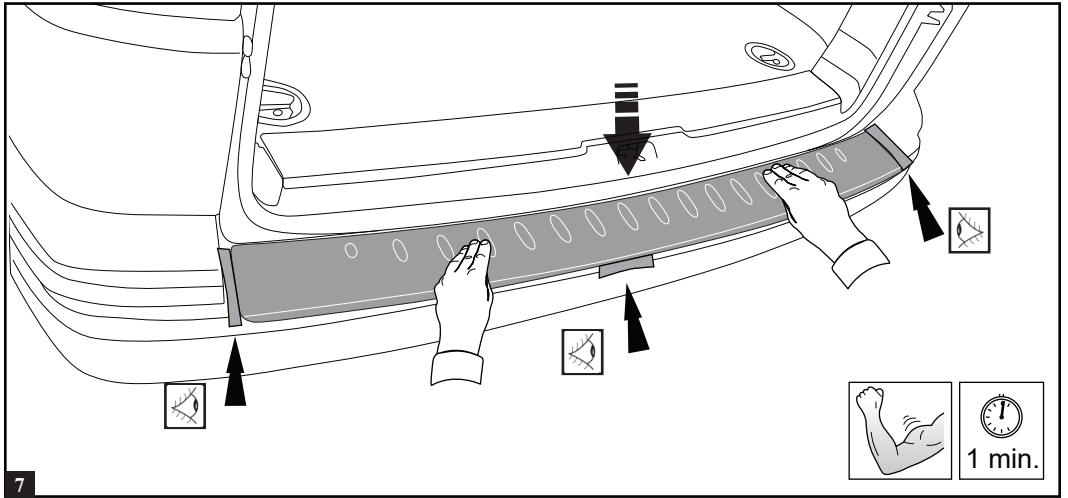

24hr
 max. 100km / h
 max. 62mph

48hr