

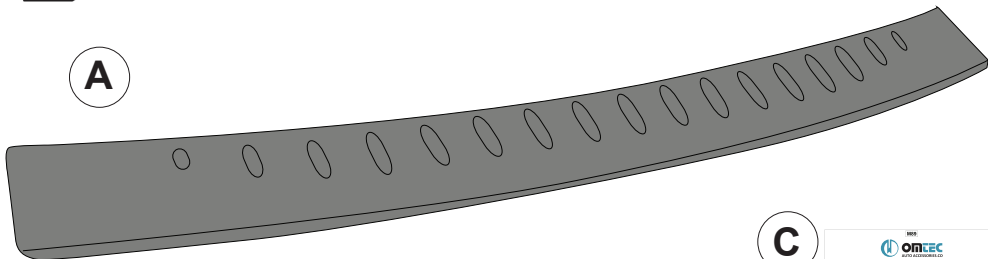

**A**



**B**



**C**

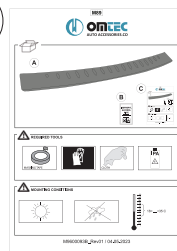

### REQUIRED TOOLS

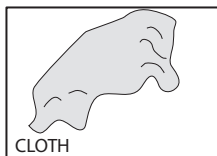

### MOUNTING CONDITIONS

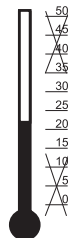
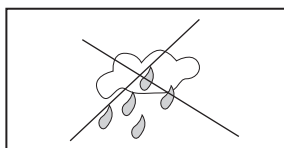
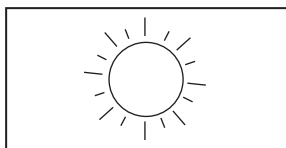

18 < .... < 35 C

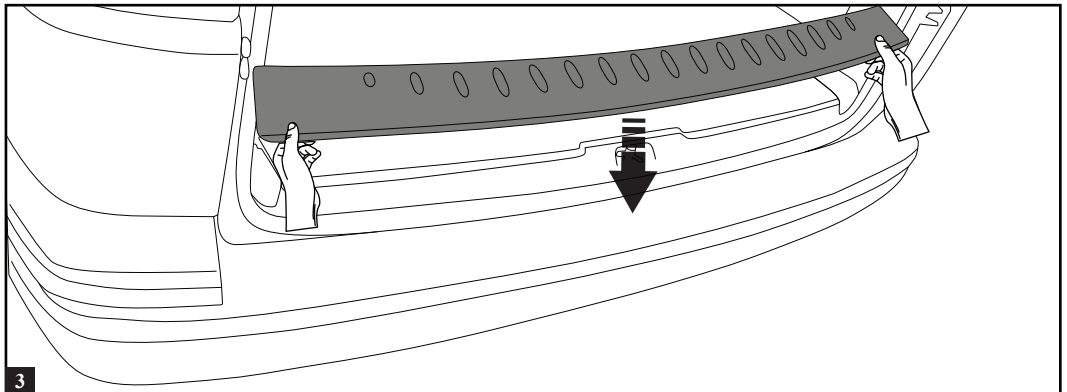
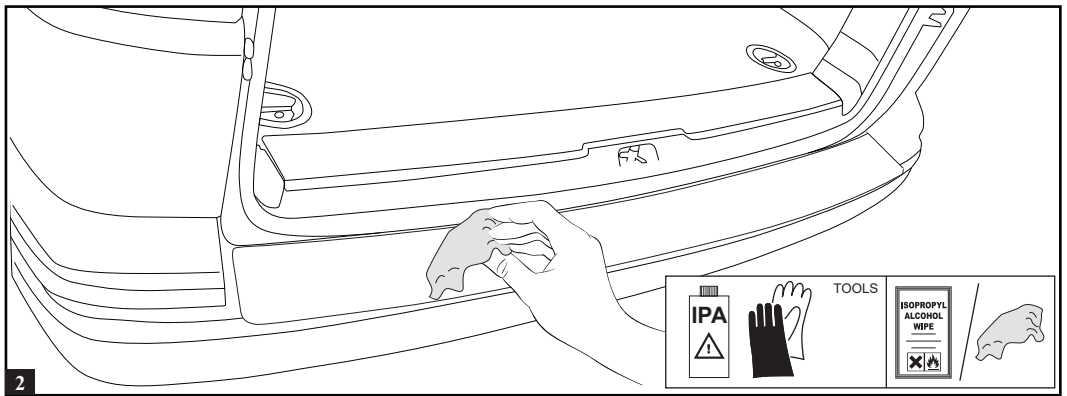
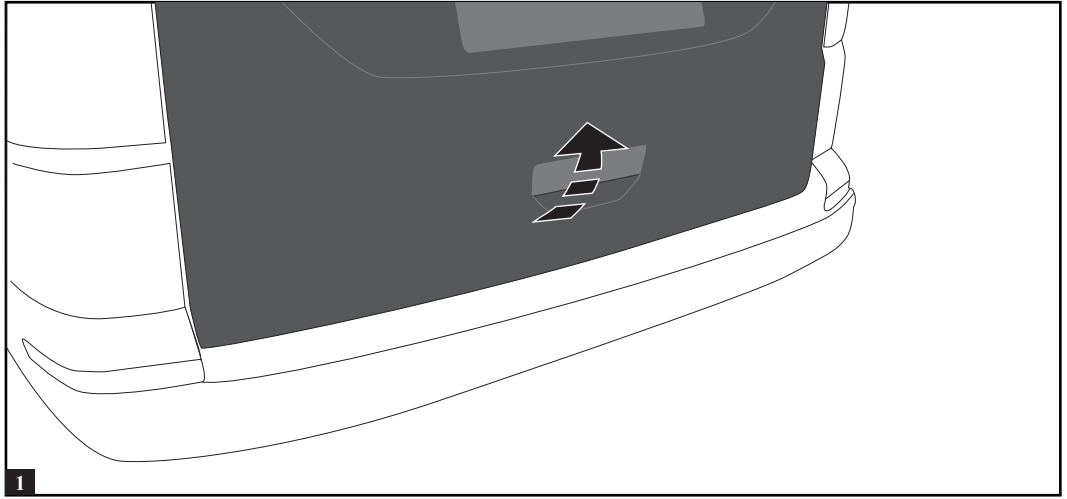

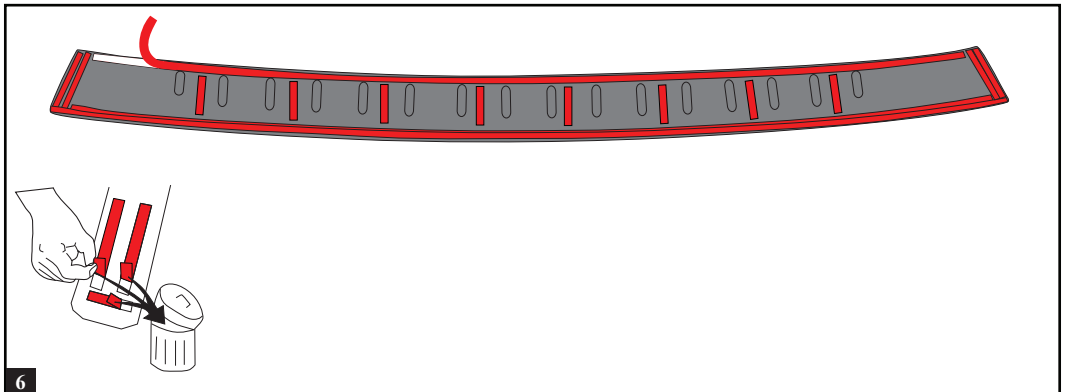
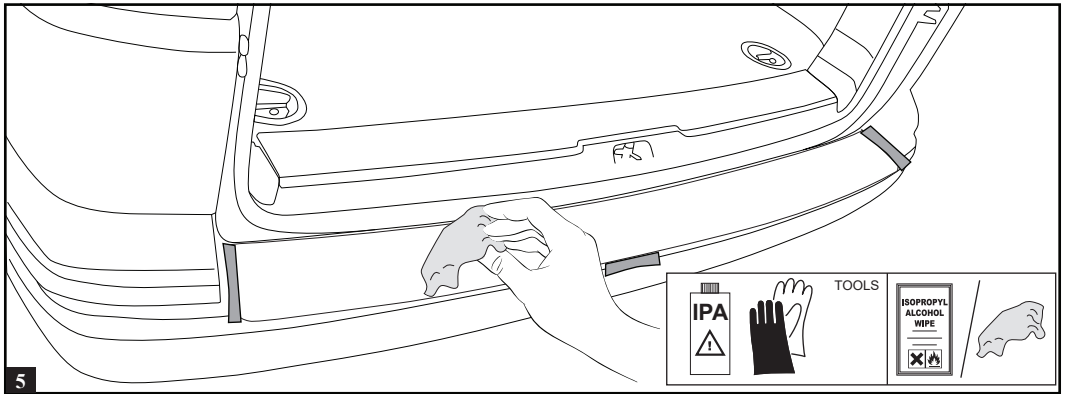
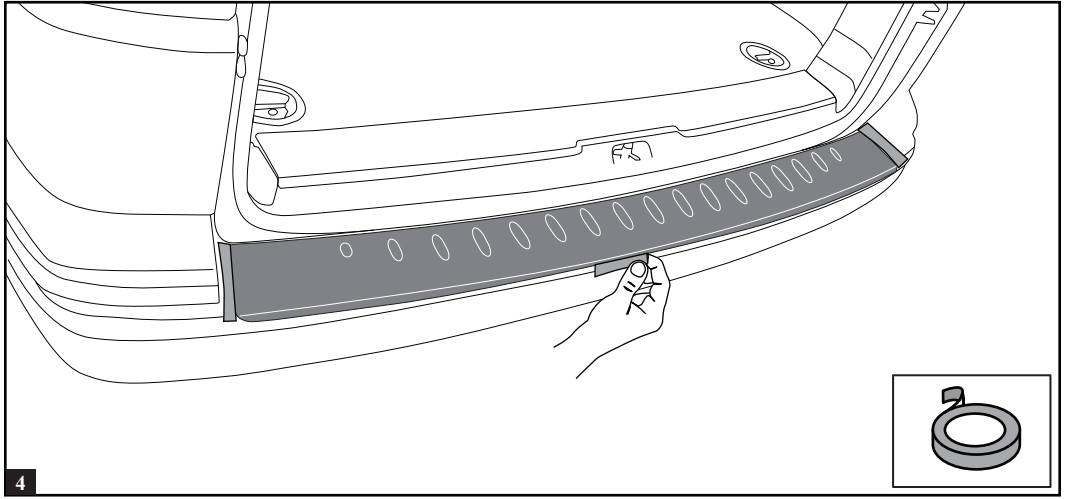

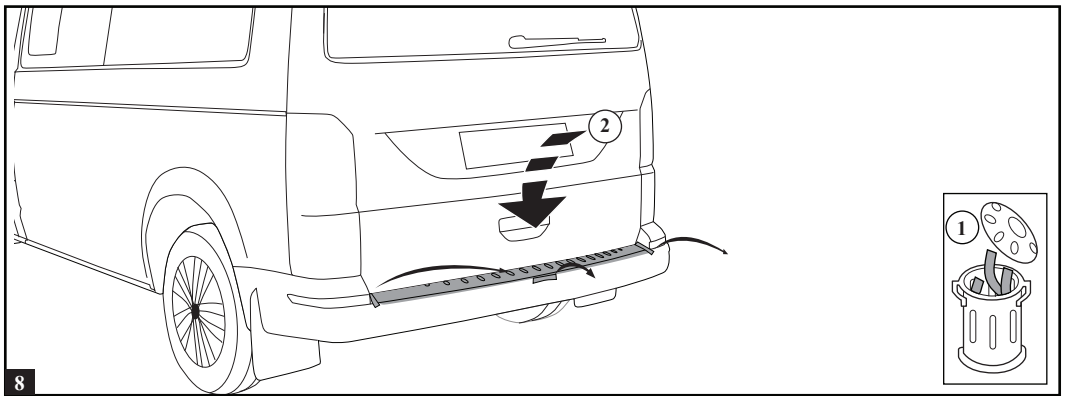
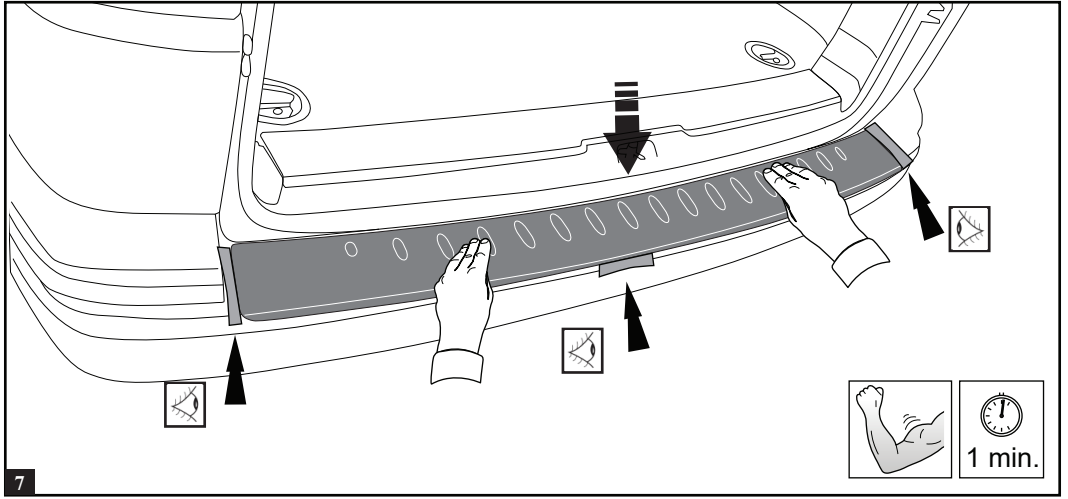

≡ 24hr  
 max. 100km / h  
 max. 62mph

48hr