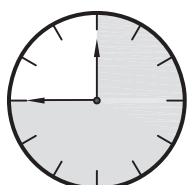




## KIA SORENTO 2013- / HYUNDAI SANTA FE 2013-

- |                                     |                                    |
|-------------------------------------|------------------------------------|
| <b>TR</b> MONTAJ TALIMATI           | <b>GB</b> FITTING INSTRUCTIONS     |
| <b>F</b> INSTRUCTIONS DE MONTAGE    | <b>P</b> INSTRUCOES DE MONTAGEM    |
| <b>NL</b> MONTAGEHANDLEIDING        | <b>PL</b> INSTRUCJE WBUDOANIA      |
| <b>H</b> FELSZERESLESI UTASITAS     | <b>ENG</b> MOUNTING INSTRUCTIONS   |
| <b>D</b> EINBAUANLEITUNG            | <b>SWE</b> MONTAGEANVISNING        |
| <b>CZ</b> POKYNY PRO MONTAZ         | <b>SLO</b> NAVODILA ZA INSTALACIJO |
| <b>ESP</b> INSTRUCCIONES DE MONTAJE | <b>RU</b> ИНСТРУКЦИЯ ПО УСТАНОВКЕ  |

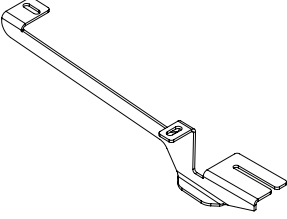
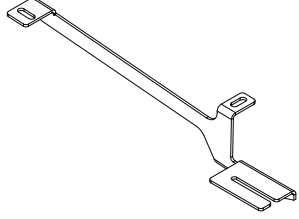
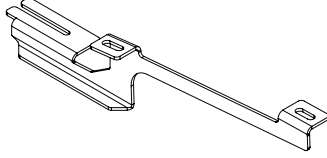
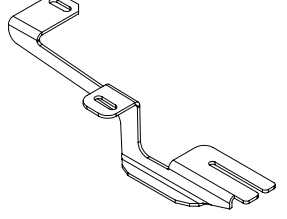
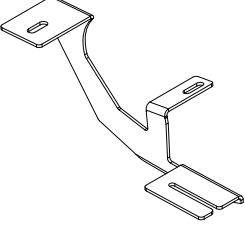
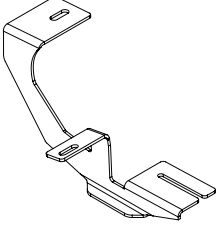
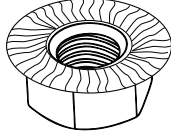
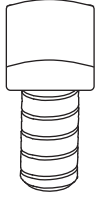
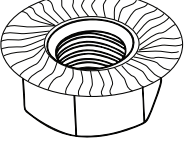
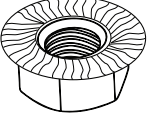
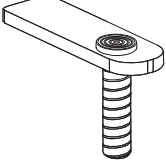


45 MINUTE



M4020971-C

# MONTAJ SETİ / INSTALLATION SET

			
<b>A</b> SOL ÖN BRAKET LEFT FRONT BRACKET	<b>B</b> SAĞ ÖN BRAKET RIGHT FRONT BRACKET	<b>C</b> SOL ORTA BRAKET LEFT MIDDLE BRACKET	<b>D</b> SAĞ ORTA BRAKET RIGHT MIDDLE BRACKET
			
<b>E</b> SOL ARKA BRAKET LEFT REAR BRACKET	<b>F</b> SAĞ ARKA BRAKET RIGHT REAR BRACKET	<b>G</b> M8 (x 12)	<b>H</b> M8 x 20 (x12)
			
<b>I</b> M10 (x 10)	<b>J</b> M6 (x 1)	<b>K</b> M10 (x 10)	

## REQUIRED TOOLS




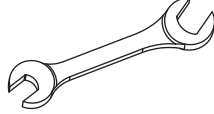

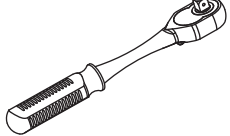
 SW10 (20Nm)	 SW13 (40Nm)	 SW17 (50Nm)	 SW13 (40Nm)	 SW17 (50Nm)	
			SW10 (20Nm)		

Fig. 1

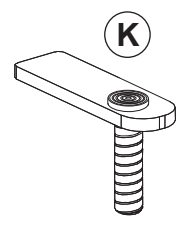
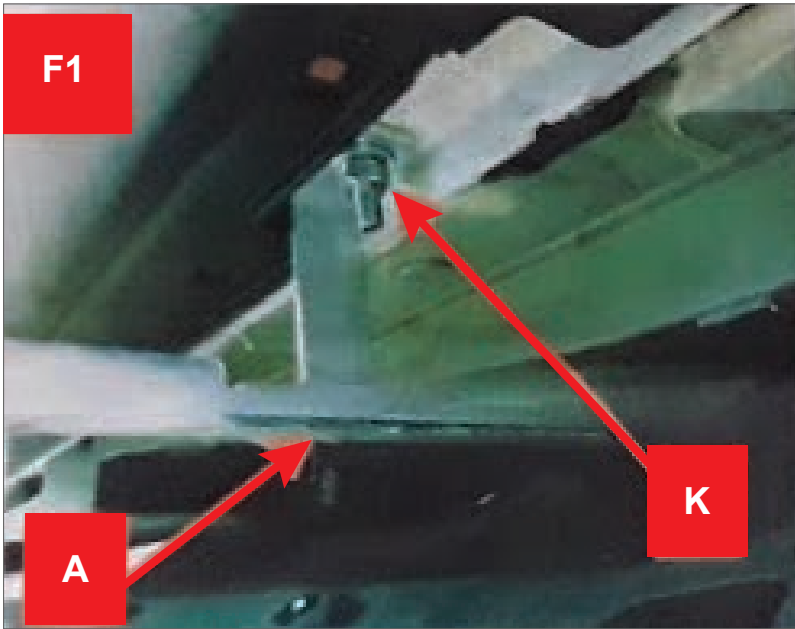
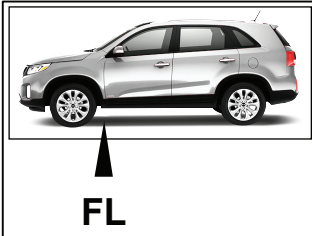


Fig. 2

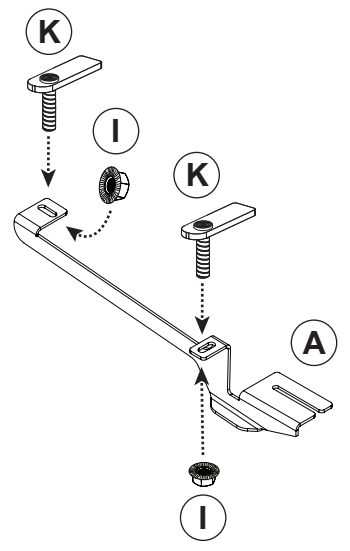
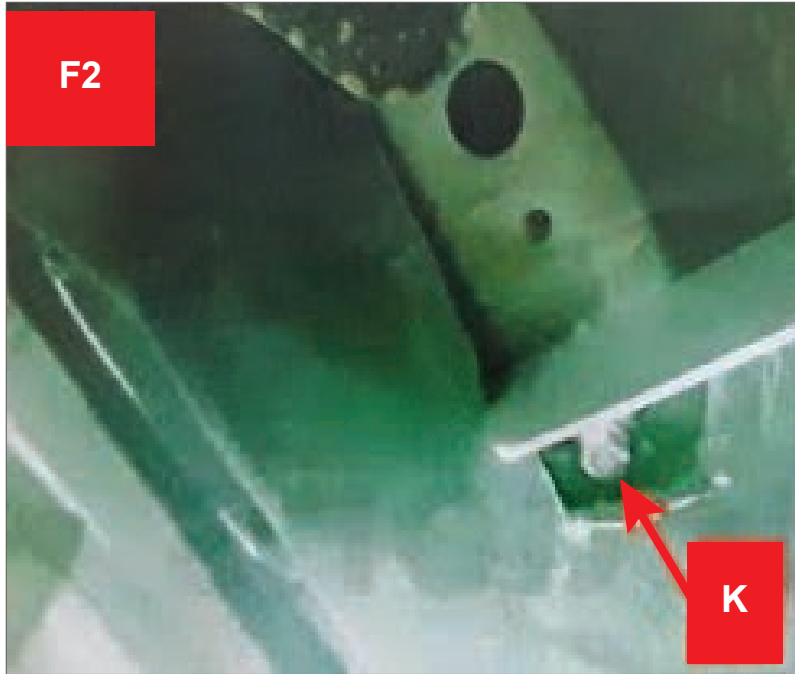
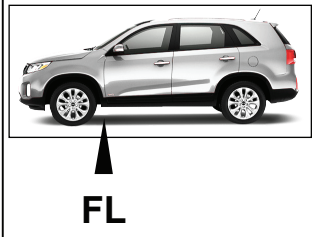


Fig. 1

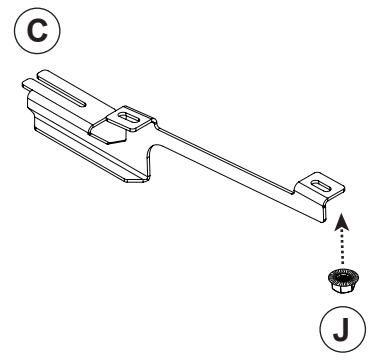
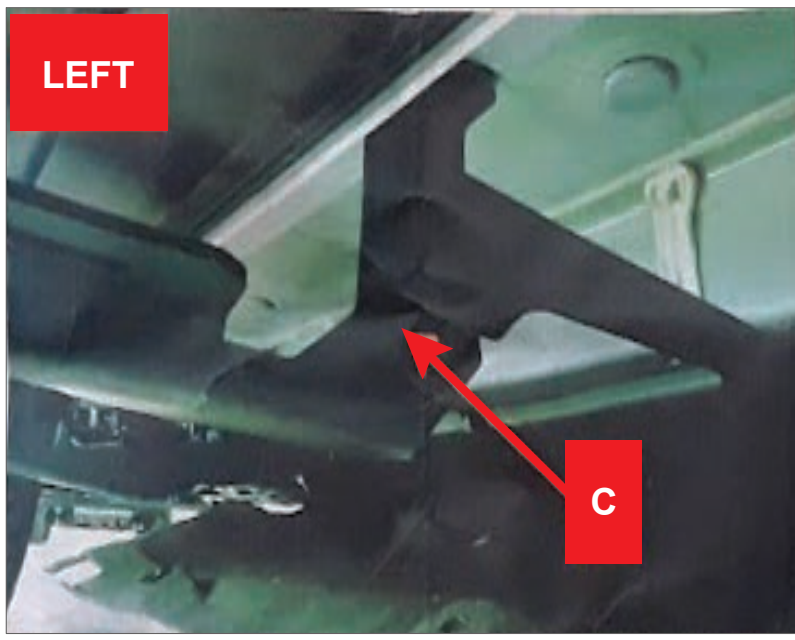
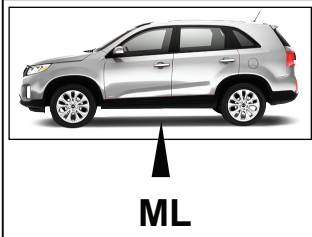


Fig. 1

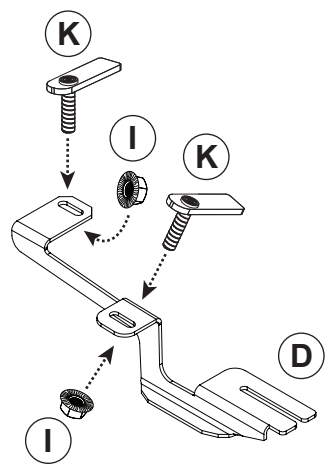
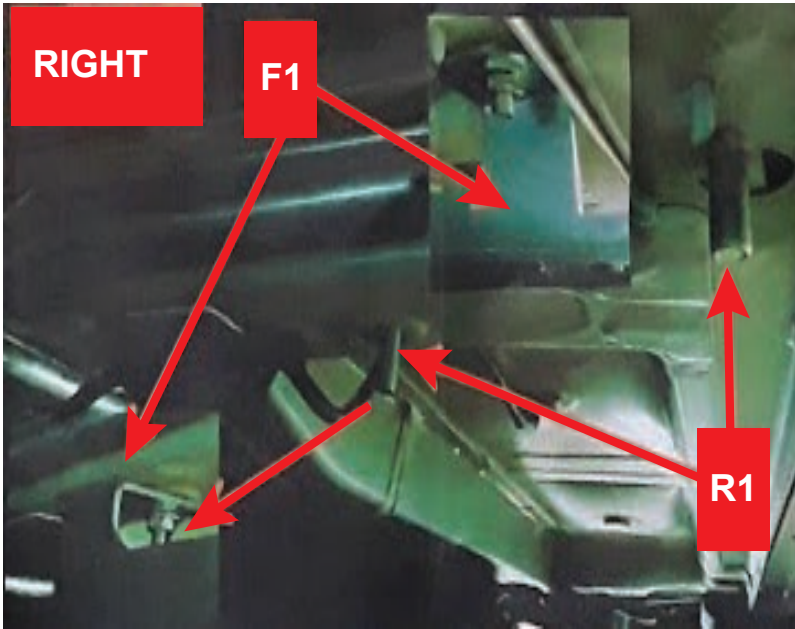
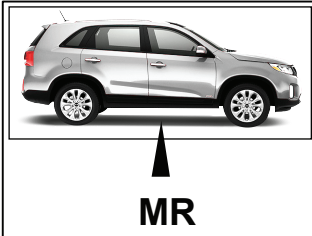


Fig. 2

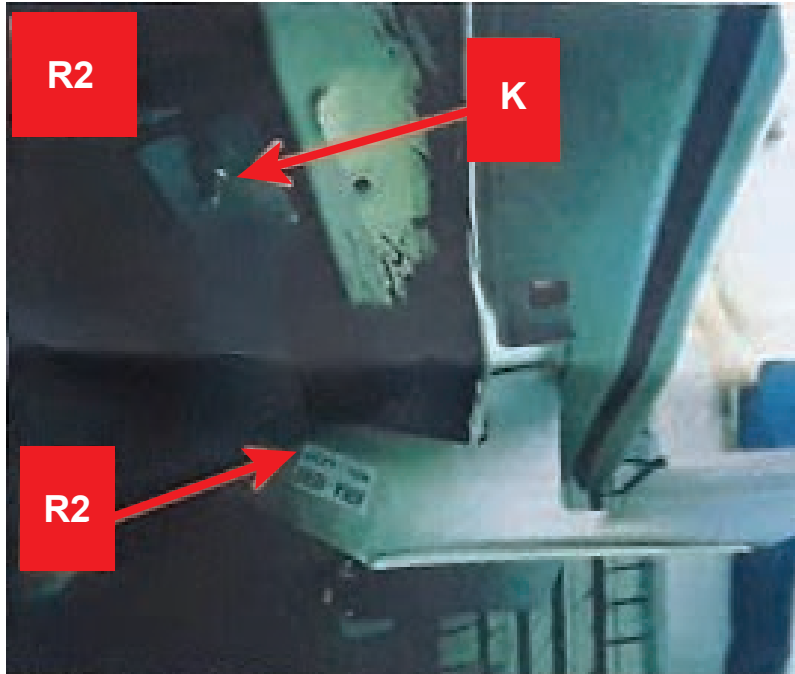
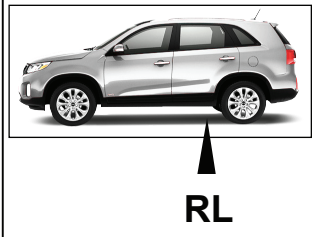


Fig. 3

