

# CROSS BAR

FITTING INSTRUCTIONS

MONTAGEANLEITUNG

RIDELLES DE TOIT

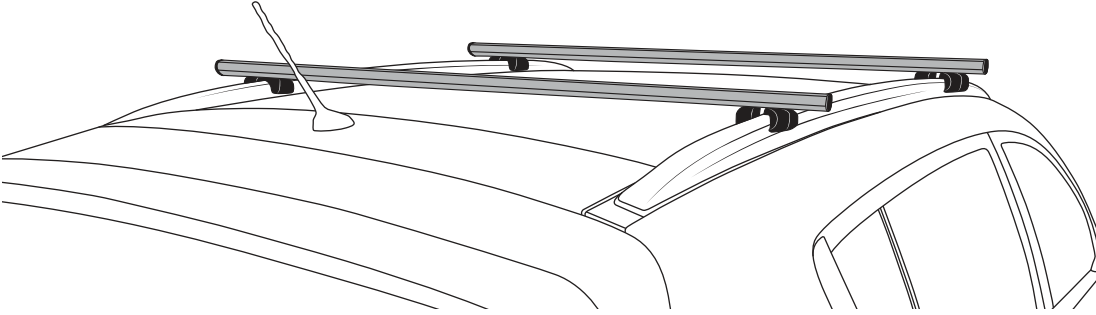

(GB)

We expressly point out that assembly not carried out properly by a competent installer will result in cancellation of any right to damage compensation, in particular those arising by virtue of the product liability act.

Contents of these kits and their fitting manuals are subject to alteration without notice, please ensure that these instructions are read and fully understood before commencing installation.

(D)

Beachten Sie bitte, dass bei Schäden in Folge unsachgemäßen Einbaus sämtliche Garantieansprüche erlöschen.

Das Recht zu Änderungen an Inhalt von Montagesatz und Einbauanleitung ohne Vorankündigung bleibt vorbehalten. Lesen Sie vor dem Einbau diese Anleitung sorgfältig durch.

(FR)

Nous tenons à insister tout particulièrement sur le fait que si ce produit n'est pas correctement assemblé par un technicien compétent, aucun droit de compensation ne sera recevable en cas de dommages, notamment les droits en vertu de la loi concernant la responsabilité à l'égard des produits.

Le contenu de ce produit, ainsi que des guides de montage qui les accompagnent est sujet à modifications sans préavis; lisez attentivement ces instructions avant de procéder à l'installation.

(NL)





De installatie moet worden uitgevoerd door een erkende, competente installateur. Incorrecte montage kan leiden tot het vervallen van elk recht op schadecompensatie, met name die met betrekking tot product aansprakelijkheid.

De inhoud van deze kits en de installatiehandleidingen kunnen worden gewijzigd zonder kennisgeving. Zorg er voor, dat u deze instructies hebt gelezen en volledig begrijpt voordat u met de installatie begint.

	=	<p><b>Max. 75 kg</b></p> <hr/> <p><b>Max. 165 lbs</b></p>
--	---	---

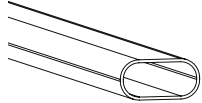
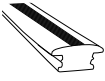
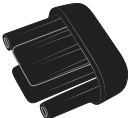
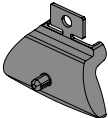
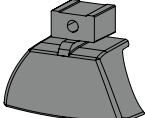
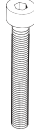
--	--

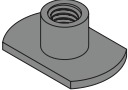
	<p><b>Sunroof - Glass Roof</b></p>

<b>A</b>  2 x		<b>B</b>  4 x		<b>C</b>  4 x	
<b>D</b>  8 x		<b>E</b>  8 x		<b>F</b>  4 x M6 x 100	
<b>G</b>  4 x M6 (Ø12)		<b>H</b>  4 x M6		<b>I</b>  1 x 5 mm	

### Required Tools



Screwdriver



Masking Tape



Meter



Scissors

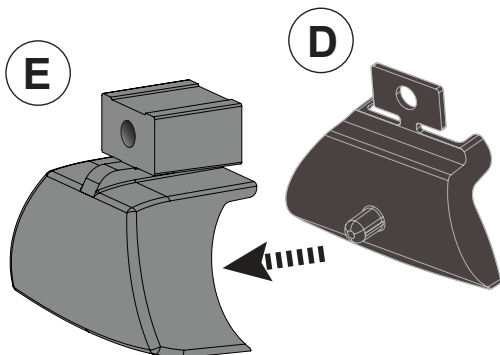

Fig 1

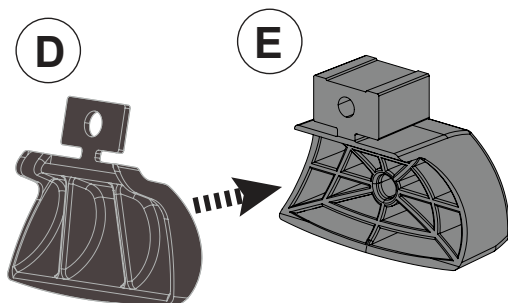
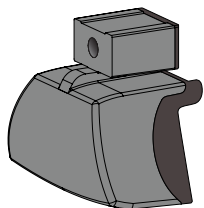

Fig 2

E + D



D + E

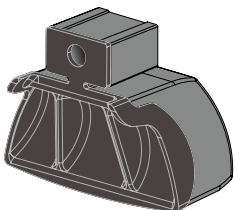
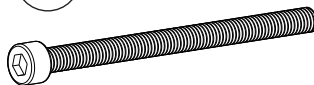

Fig 3

F



G



Fig 4

F + G

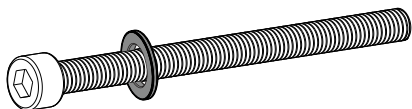

Fig 5

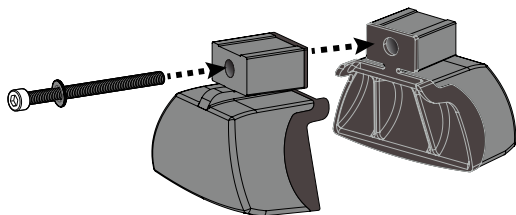

Fig 6

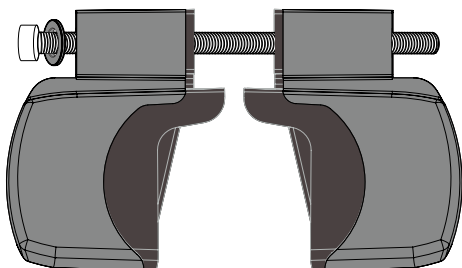

Fig 7

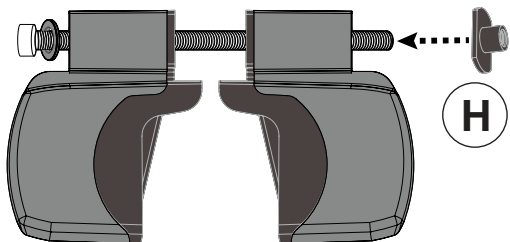

Fig 8

Max. 4 Nm

35.40 in-lbf

2.95 ft-lbf

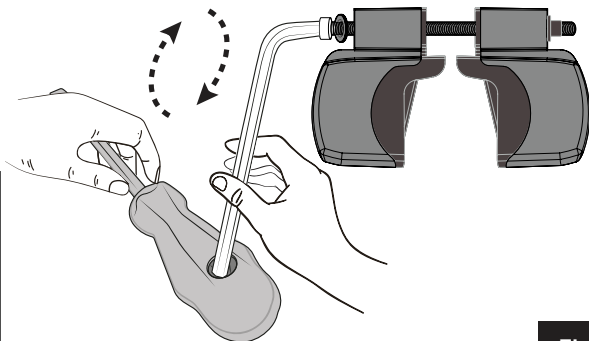
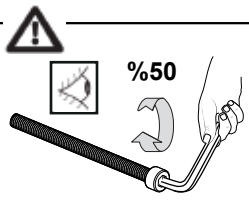

Fig 9

4

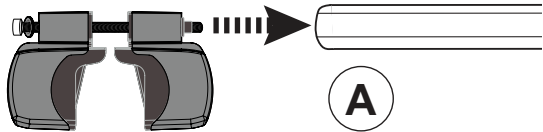

Fig 10

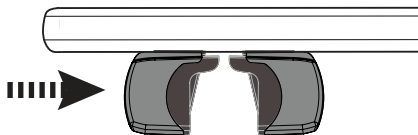

Fig 11

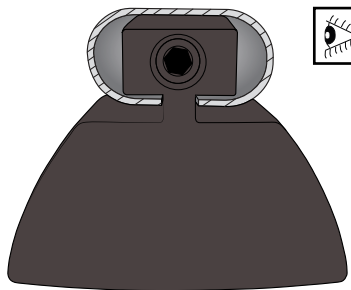
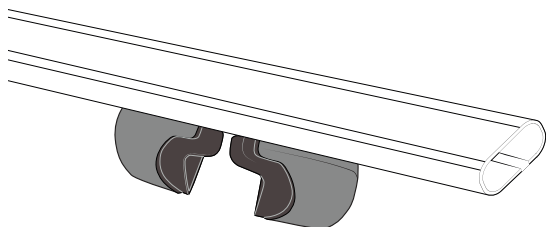

Fig 12

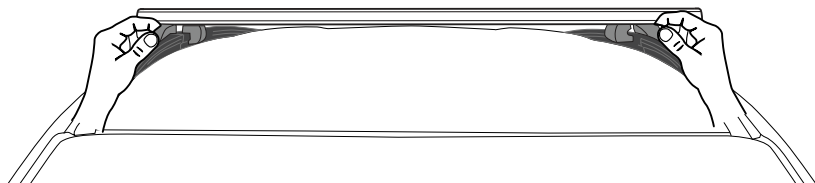
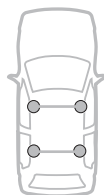
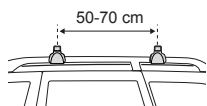

Fig 13

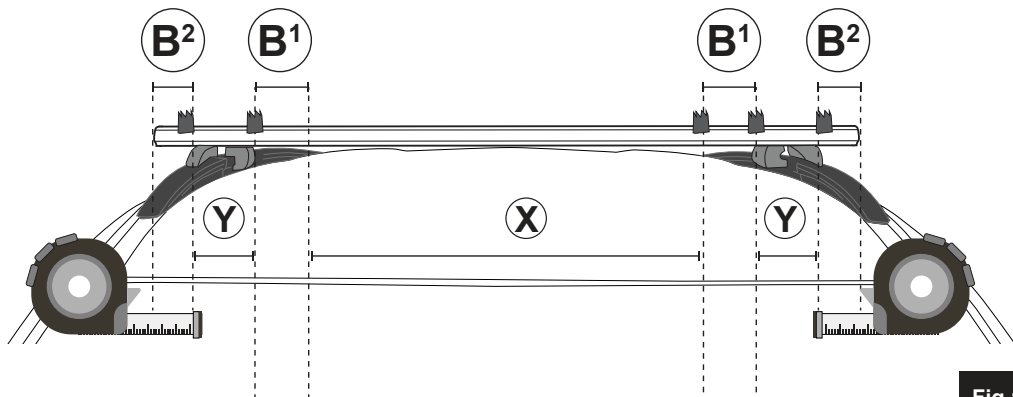

Fig 14

5

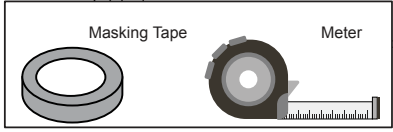

Fig 15

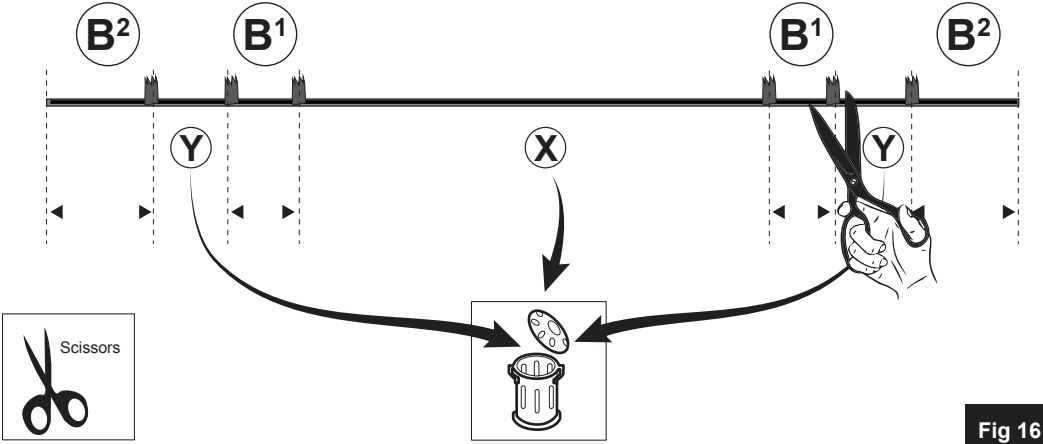

Fig 16



Fig 17

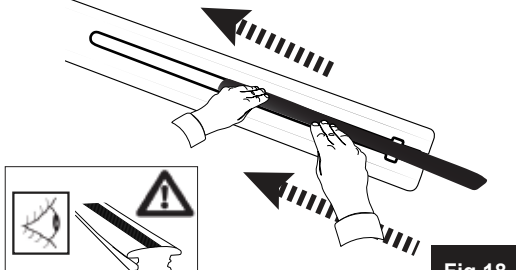

Fig 18

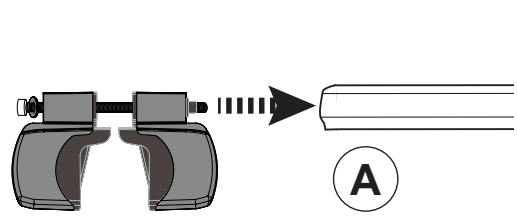
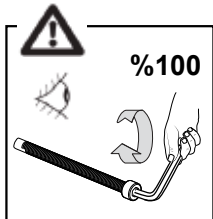
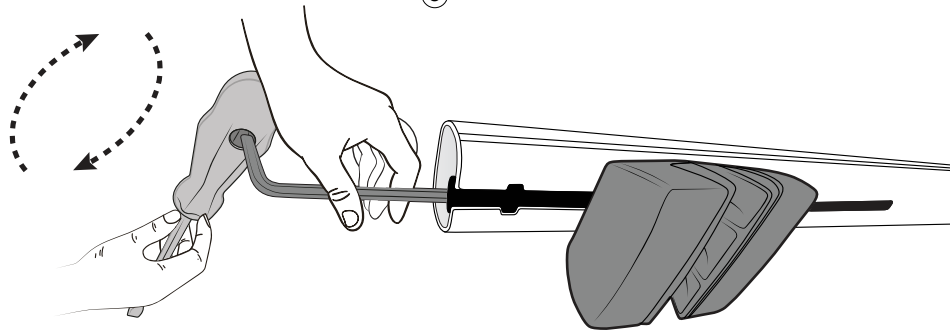

Fig 19

6



**%100**

**Max. 8 Nm**

**70.80 in-lbf**

**5.90 ft-lbf**

**Fig 20**

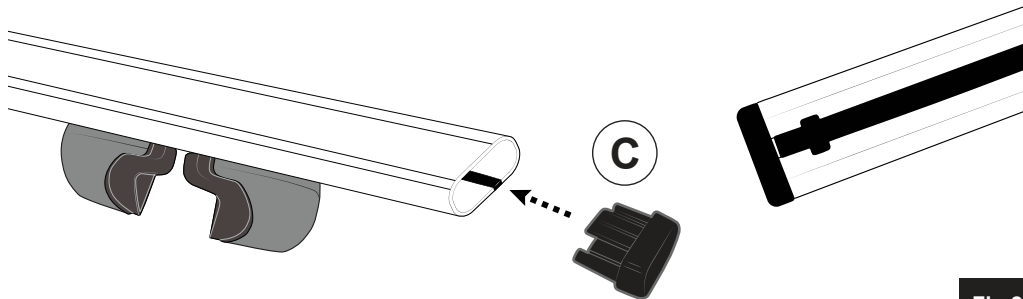

**Fig 21**

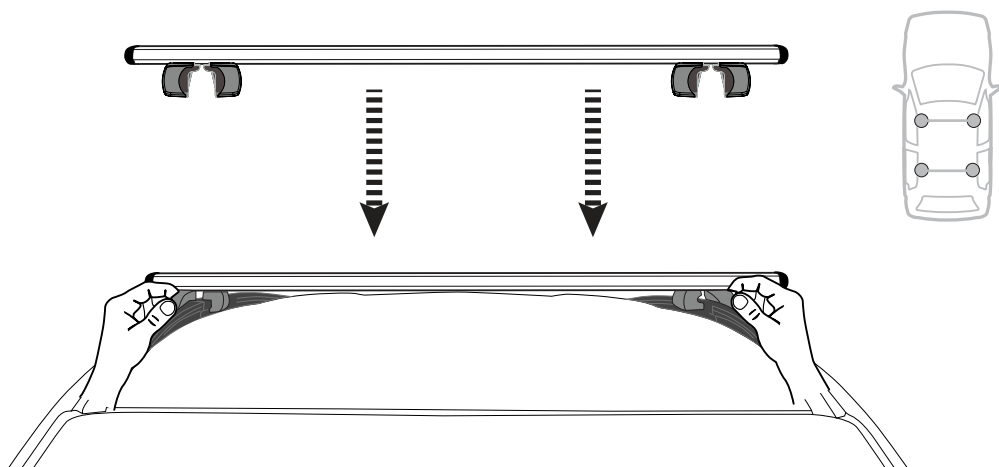

**Fig 22**